



Aluminium Profile

ΠΡΟΦΙΛ ΑΛΟΥΜΙΝΙΟΥ

ΕΞΑΡΤΗΜΑΤΑ ΣΥΝΔΕΣΗΣ

ΠΑΡΕΛΚΟΜΕΝΑ ΣΥΝΔΕΣΗΣ

ΣΤΟΙΧΕΙΑ ΣΥΝΔΕΣΗΣ

ΕΦΑΡΜΟΓΕΣ

e-mail: sales@aluminium-profile.gr
www.aluminium-profile.gr



Τα Aluminium Profile ήρθαν για να κάνουν την ζωή μας πιο εύκολη.
Τα Προφίλ Αλουμινίου είναι κατασκευασμένα από κράμα αλουμινίου 6063
και είναι ανοδιωμένα.

Δεν χρειάζονται βαφή, γυάλισμα, καθώς και περαιτέρω κατεργασία
της επιφάνειάς τους όπως ο χάλυβας.

Είναι εξοπλισμένα με αυλάκια 6mm, 8mm και 10mm,
που καθιστούν δυνατό να επισυνάψετε στοιχεία
στερέωσης με τα κατάλληλα εξαρτήματα και στοιχεία σύνδεσης.

Τα μεγαλύτερα πλεονεκτήματα των Προφίλ είναι η γρήγορη
και η καθαρή τοποθέτηση, η ανθεκτικότητα
και η χρήση τους σε πολλές εφαρμογές.

Τα στοιχεία σύνδεσης, που έχουν σχεδιαστεί κατάλληλα
για τα προφίλ μπορούν να τοποθετηθούν εύκολα και γρήγορα

Είναι δυνατόν να γίνει οποιαδήποτε αλλαγή των κατασκευών ακόμα και μετά το τελείωμά τους.

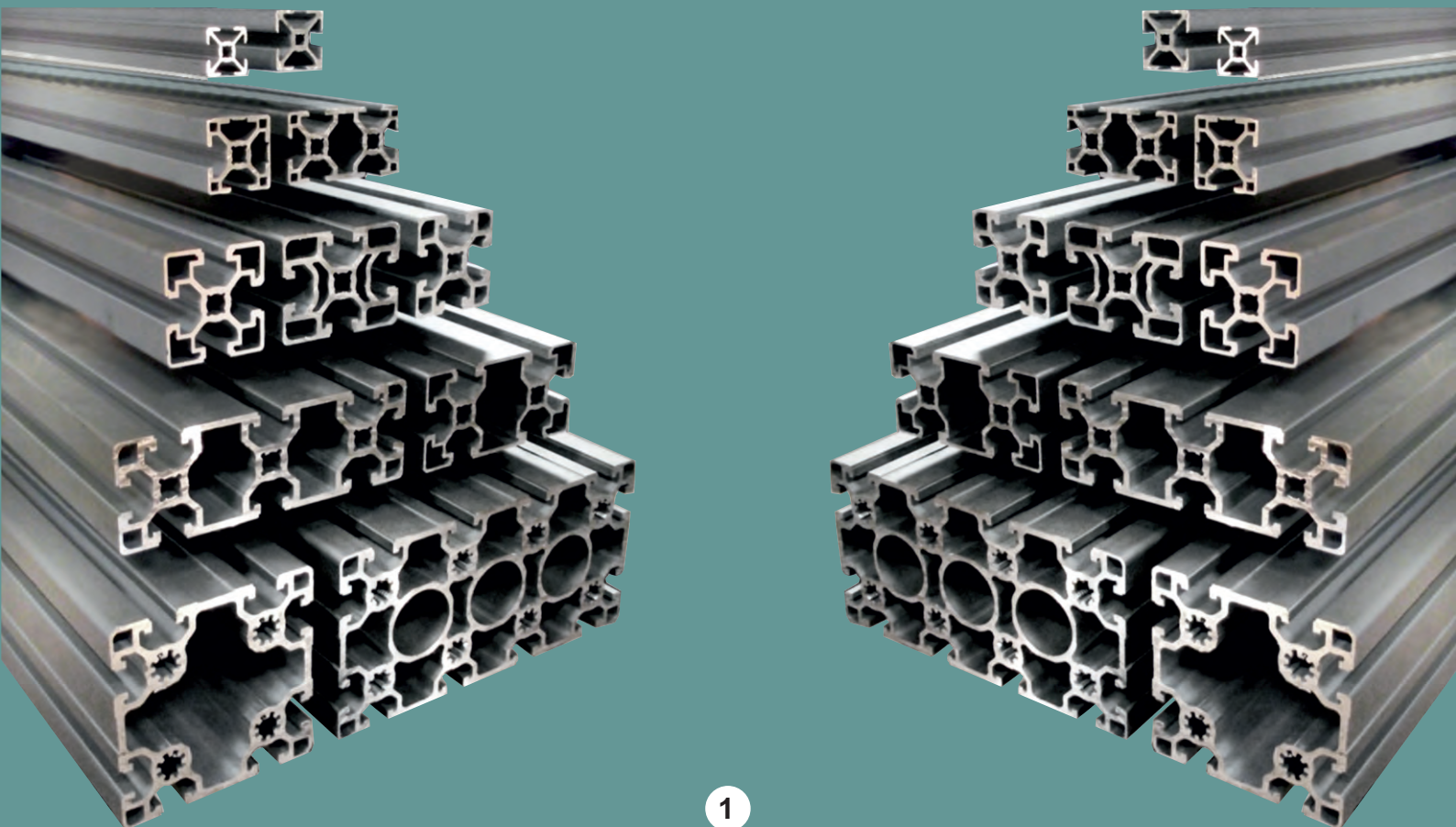

ΠΡΟΦΙΛ ΑΛΟΥΜΙΝΙΟΥ

20X20 profile

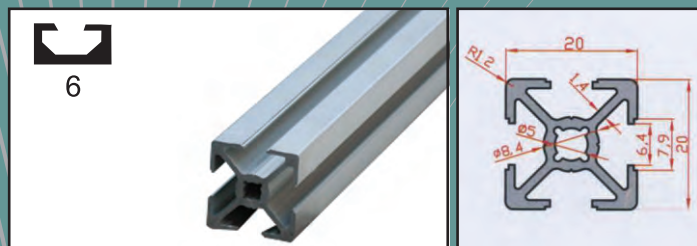

Εξ.Διάσταση	Υλικό	Μήκος (μέτρα)	Μάζα	Κωδικός
20 x 20	6063	6	0,36 kg/m	M 63

25X25 profile

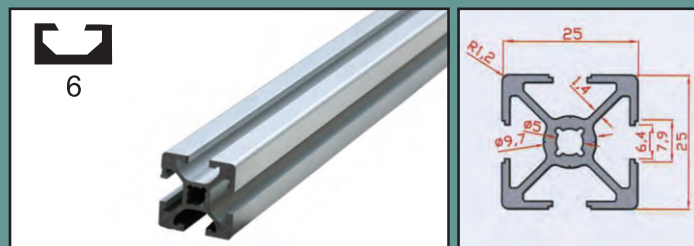

Εξ.Διάσταση	Υλικό	Μήκος (μέτρα)	Μάζα	Κωδικός
25 x 25	6063	6	0,55 kg/m	M 63/A

20X40 profile



Εξ.Διάσταση	Υλικό	Μήκος (μέτρα)	Μάζα	Κωδικός
20 x 40	6063	6	0,68 kg/m	M 99

20X80 profile

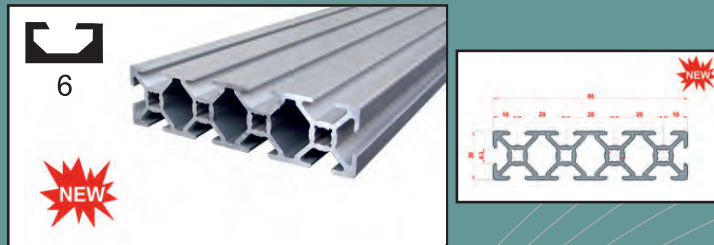

Εξ.Διάσταση	Υλικό	Μήκος (μέτρα)	Μάζα	Κωδικός
20 x 80	6063	6	1,28 kg/m	M 95

30X30 profile



Εξ.Διάσταση	Υλικό	Μήκος (μέτρα)	Μάζα	Κωδικός
30 x 30	6063	6	0,86 kg/m	M 22

30X45 profile

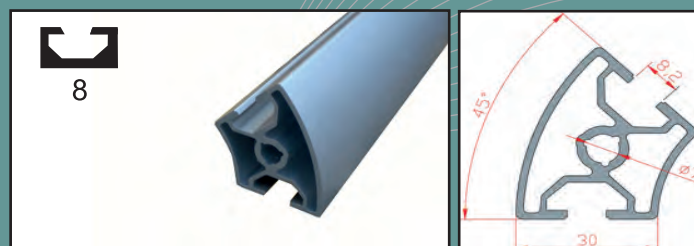

Εξ.Διάσταση	Υλικό	Μήκος (μέτρα)	Μάζα	Κωδικός
30 x 45	6063	6	0,88 kg/m	M 30 x 45/D

30X60 profile

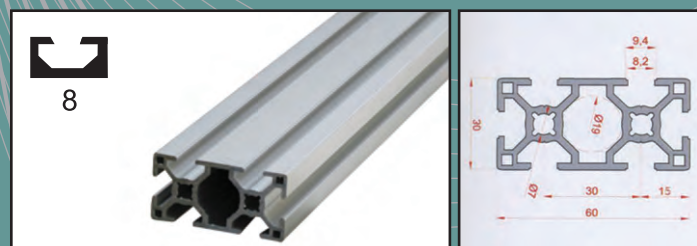

Εξ.Διάσταση	Υλικό	Μήκος (μέτρα)	Μάζα	Κωδικός
30 x 60	6063	6	1,58 kg/m	M 26

30X90 profile

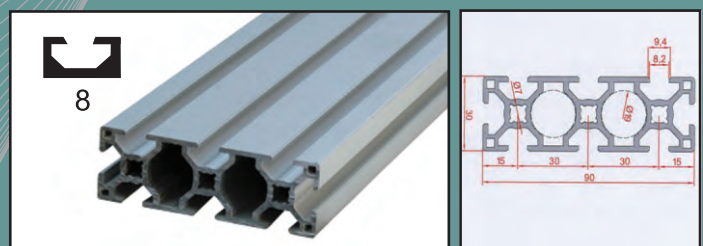

Εξ.Διάσταση	Υλικό	Μήκος (μέτρα)	Μάζα	Κωδικός
30 x 90	6063	6	2,14 kg/m	M 19

ΠΡΟΦΙΛ ΑΛΟΥΜΙΝΙΟΥ

35X35 profile

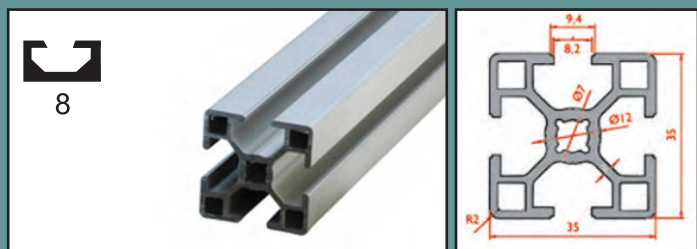

Εξ.Διάσταση	Υλικό	Μήκος (μέτρα)	Μάζα	Κωδικός
35 x 35	6063	6	0,98 kg/m	M 11

40X40 Heavy profile

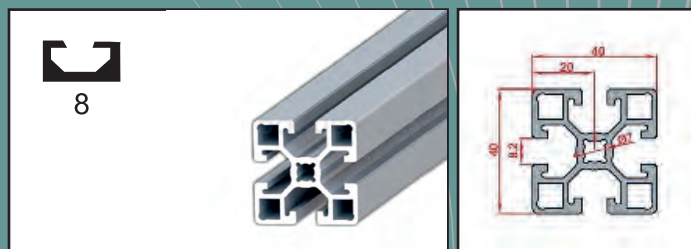

Εξ.Διάσταση	Υλικό	Μήκος (μέτρα)	Μάζα	Κωδικός
40 x 40	6063	6	1,38 kg/m	M 04/G

40X40 profile

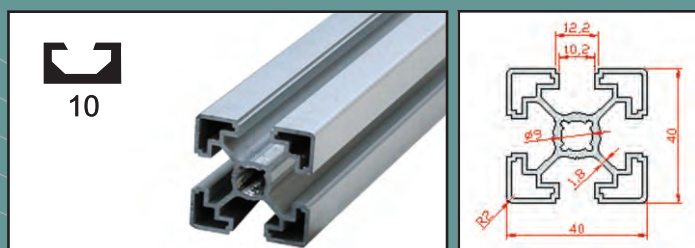

Εξ.Διάσταση	Υλικό	Μήκος (μέτρα)	Μάζα	Κωδικός
40 x 40	6063	6	1,15 kg/m	M 04

40X40 45° angled



Εξ.Διάσταση	Υλικό	Μήκος (μέτρα)	Μάζα	Κωδικός
40 x 40	6063	6	0,89 kg/m	M 40/A

40X80 profile

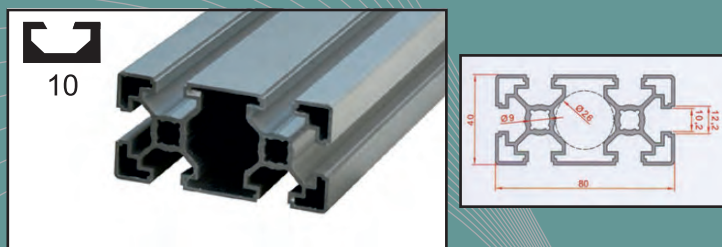

Εξ.Διάσταση	Υλικό	Μήκος (μέτρα)	Μάζα	Κωδικός
40 x 80	6063	6	1,85 kg/m	M 03

40X120 profile

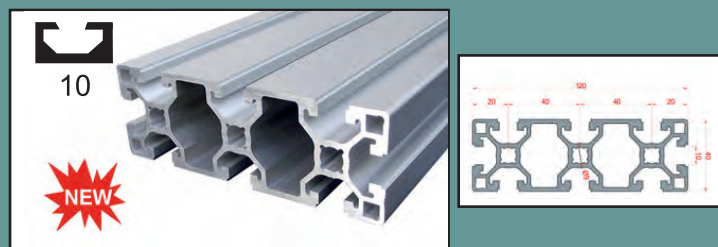

Εξ.Διάσταση	Υλικό	Μήκος (μέτρα)	Μάζα	Κωδικός
40 x 120	6063	6	3,76 kg/m	M 21

45X60 profile

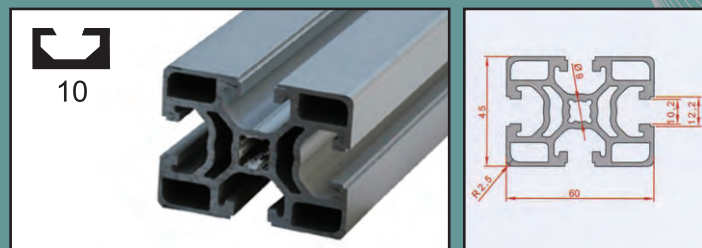

Εξ.Διάσταση	Υλικό	Μήκος (μέτρα)	Μάζα	Κωδικός
45 x 60	6063	6	2,51 kg/m	M 13

60X60 profile

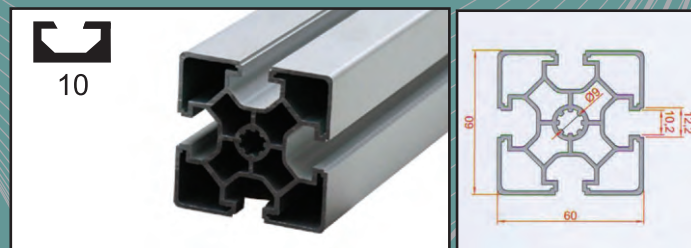

Εξ.Διάσταση	Υλικό	Μήκος (μέτρα)	Μάζα	Κωδικός
60 x 60	6063	6	2,46 kg/m	M 28

ΠΡΟΦΙΛ ΑΛΟΥΜΙΝΙΟΥ

60X60 profile

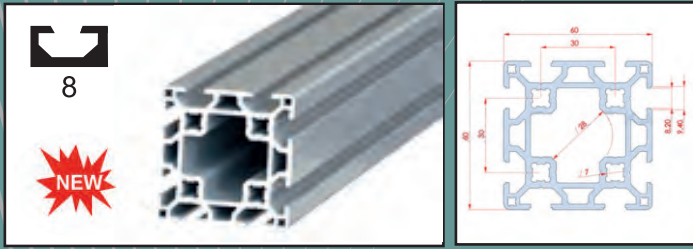

Εξ.Διάσταση	Υλικό	Μήκος (μέτρα)	Μάζα	Κωδικός
60 x 60	6063	6	2,98 kg/m	M 28/B

30X30 Closed profile

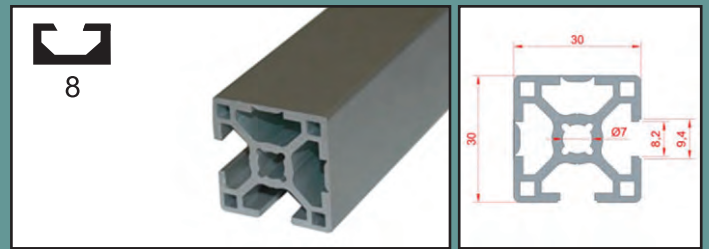

Εξ.Διάσταση	Υλικό	Μήκος (μέτρα)	Μάζα	Κωδικός
30 x 30	6063	6	0,865 kg/m	M 22-K

40X40 Closed profile

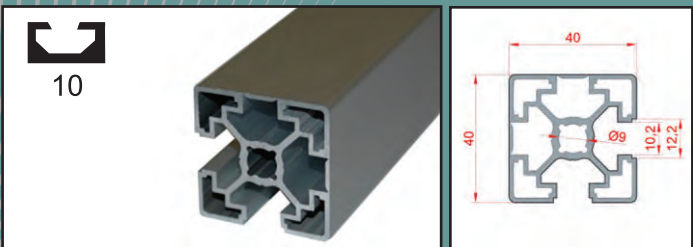

Εξ.Διάσταση	Υλικό	Μήκος (μέτρα)	Μάζα	Κωδικός
40 x 40	6063	6	1,27 kg/m	M 04-K

40X80 Closed profile

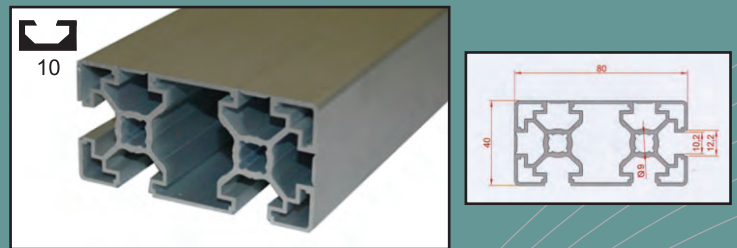

Εξ.Διάσταση	Υλικό	Μήκος (μέτρα)	Μάζα	Κωδικός
40 x 80	6063	6	2,04 kg/m	M 03-K

45X45 profile



Εξ.Διάσταση	Υλικό	Μήκος (μέτρα)	Μάζα	Κωδικός
45 x 45	6063	6	1,46 kg/m	M 12

45X90 profile



Εξ.Διάσταση	Υλικό	Μήκος (μέτρα)	Μάζα	Κωδικός
45 x 90	6063	6	2,55 kg/m	M 10

80X80 profile

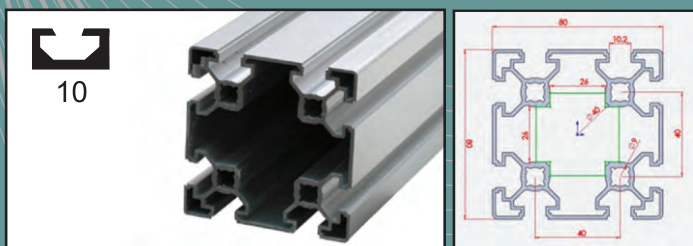

Εξ.Διάσταση	Υλικό	Μήκος (μέτρα)	Μάζα	Κωδικός
80 x 80	6063	6	3,16 kg/m	M 02

80X80 Heavy profile

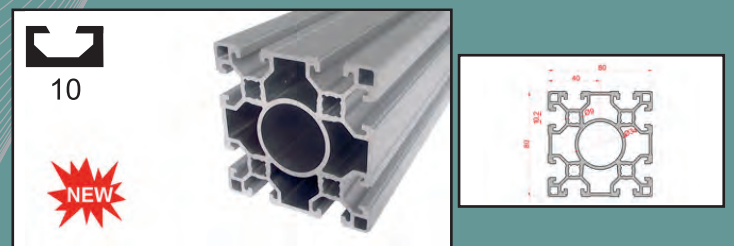

Εξ.Διάσταση	Υλικό	Μήκος (μέτρα)	Μάζα	Κωδικός
80 x 80	6063	6	4,68 kg/m	M 02/A

ΠΡΟΦΙΛ ΑΛΟΥΜΙΝΙΟΥ

90X90 profile

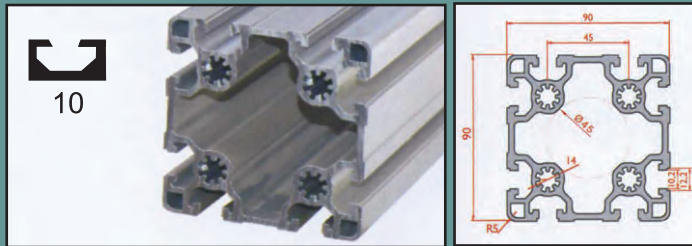

Εξ.Διάσταση	Υλικό	Μήκος (μέτρα)	Μάζα	Κωδικός
90 x 90	6063	6	5,83 kg/m	M 30

90X90 Heavy profile

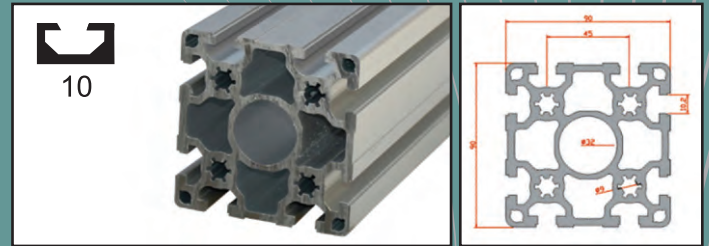

Εξ.Διάσταση	Υλικό	Μήκος (μέτρα)	Μάζα	Κωδικός
90 x 90	6063	6	7,54 kg/m	M 30/A

45X135 profile

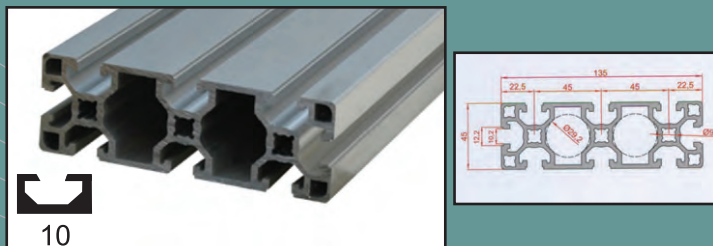

Εξ.Διάσταση	Υλικό	Μήκος (μέτρα)	Μάζα	Κωδικός
45 x 135	6063	6	4,85 kg/m	M 60

45X180 profile

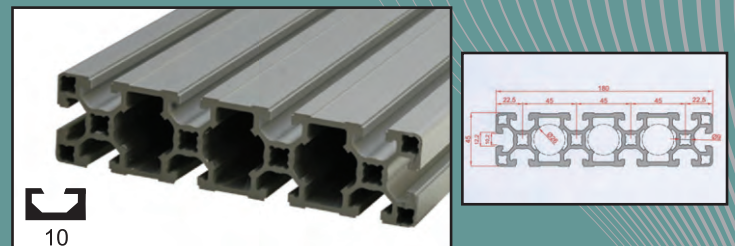

Εξ.Διάσταση	Υλικό	Μήκος (μέτρα)	Μάζα	Κωδικός
45 x 180	6063	6	6,77 kg/m	M 15

90X180 profile

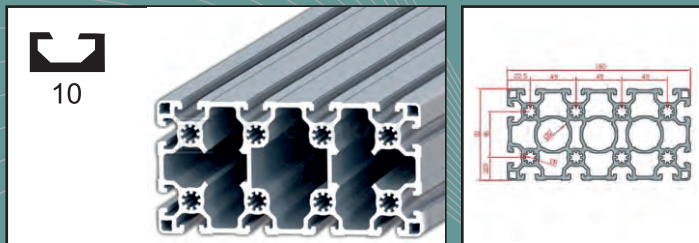

Εξ.Διάσταση	Υλικό	Μήκος (μέτρα)	Μάζα	Κωδικός
90 x 180	6063	6	10,95 kg/m	M 14/L

90X180 Heavy profile

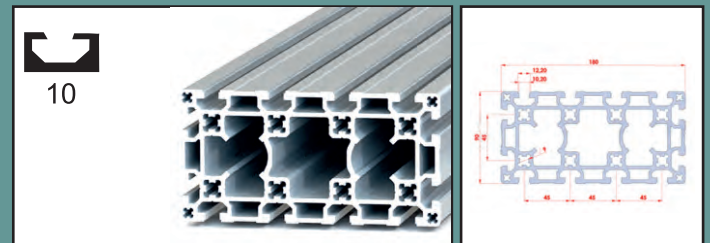

Εξ.Διάσταση	Υλικό	Μήκος (μέτρα)	Μάζα	Κωδικός
90 x 180	6063	6	12,64 kg/m	M 14

15X120 surface coating profile

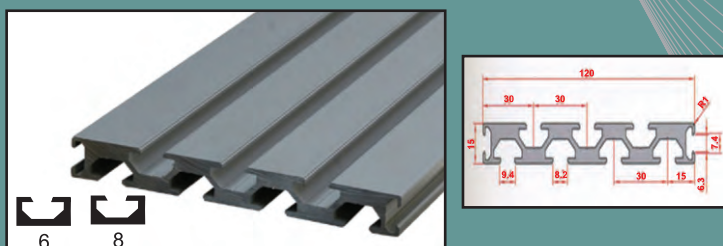

Εξ.Διάσταση	Υλικό	Μήκος (μέτρα)	Μάζα	Κωδικός
15 x 120	6063	6	2,25 kg/m	M 17

22,5X180 surface coating profile

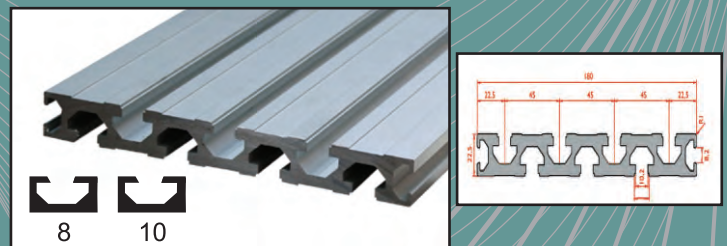

Εξ.Διάσταση	Υλικό	Μήκος (μέτρα)	Μάζα	Κωδικός
22,5 x 180	6063	6	5,70 kg/m	M 16

ΠΡΟΦΙΛ ΑΛΟΥΜΙΝΙΟΥ

22X140 surface coating profile

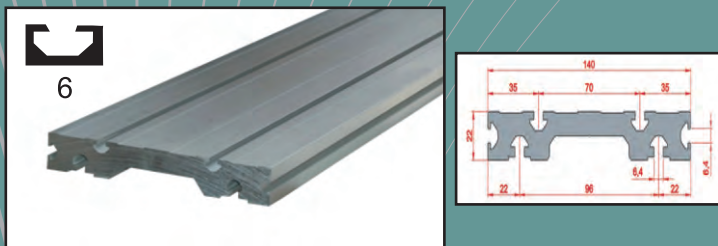

Εξ.Διάσταση	Υλικό	Μήκος (μέτρα)	Μάζα	Κωδικός
22 x 140	6063	6	5,39 kg/m	M 15ZE-MP

27X170 surface coating profile

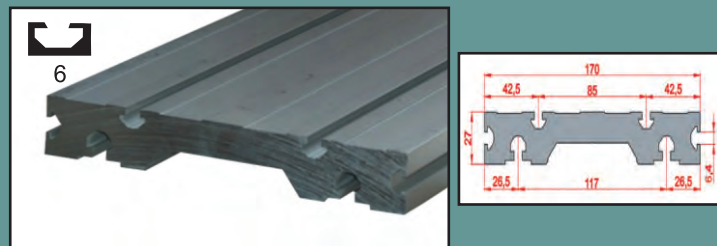

Εξ.Διάσταση	Υλικό	Μήκος (μέτρα)	Μάζα	Κωδικός
27 x 170	6063	6	8,77 kg/m	M 20ZE-MP

20X20 radius



Εξ.Διάσταση	Υλικό	Μήκος (μέτρα)	Μάζα	Κωδικός
20 x 20	6063	6	0,38 kg/m	M 63/R

30X30 radius

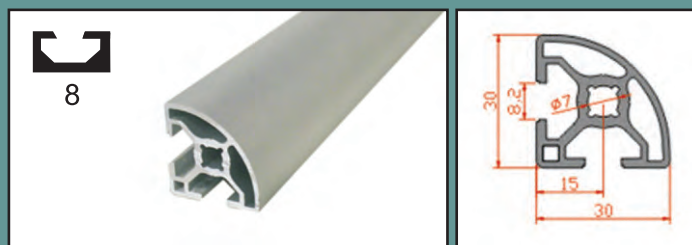

Εξ.Διάσταση	Υλικό	Μήκος (μέτρα)	Μάζα	Κωδικός
30 x 30	6063	6	0,72 kg/m	M 22/R

45X45 radius

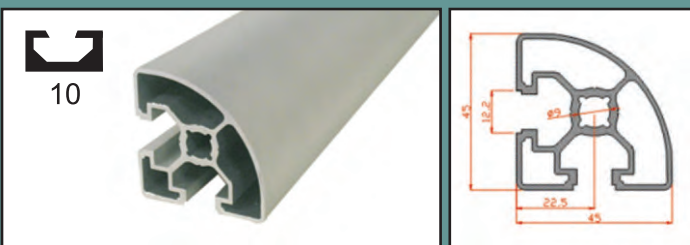

Εξ.Διάσταση	Υλικό	Μήκος (μέτρα)	Μάζα	Κωδικός
45 x 45	6063	6	1,17 kg/m	M 21/R

45X75 Conveyor profile

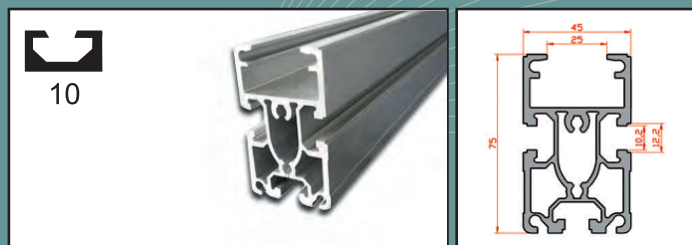

Εξ.Διάσταση	Υλικό	Μήκος (μέτρα)	Μάζα	Κωδικός
45 x 75	6063	6	2,54 kg/m	M 24

23X127 Conveyor profile

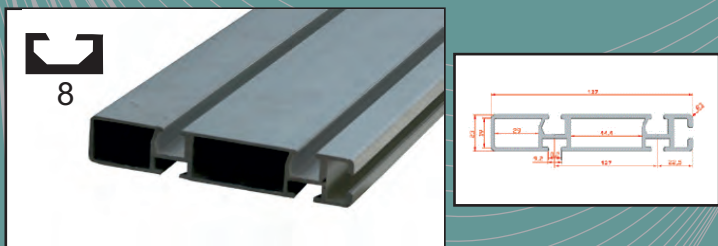

Εξ.Διάσταση	Υλικό	Μήκος (μέτρα)	Μάζα	Κωδικός
23 x 127	6063	6	2,05 kg/m	M 29

25X105 & 25X150 Conveyor profile

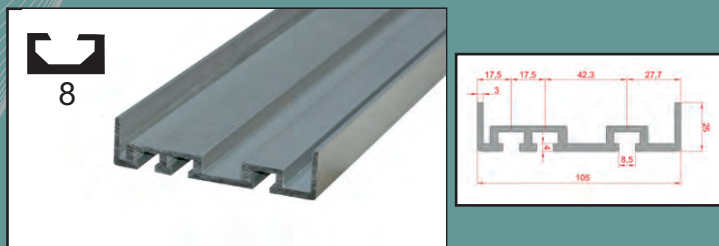

Εξ.Διάσταση	Υλικό	Μήκος (μέτρα)	Μάζα	Κωδικός
25 x 105	6063	6	1,98 kg/m	M 29/A
25 x 150	6063	6	2,62 kg/m	M 29/B

ΠΡΟΦΙΛ ΑΛΟΥΜΙΝΙΟΥ

Ø 4 block guide profile

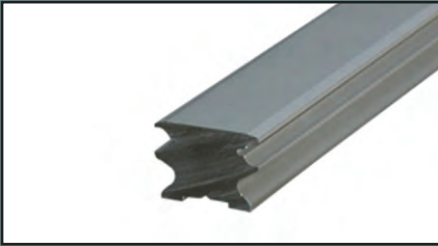

ΚΩΔΙΚΟΣ.: M 073
Μήκος: 6 m

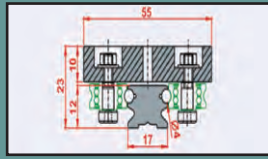

Ø 6 block guide profile

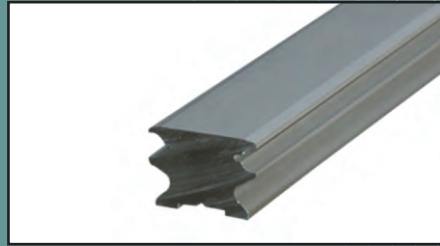

ΚΩΔΙΚΟΣ.: M 068
Μήκος: 6 m

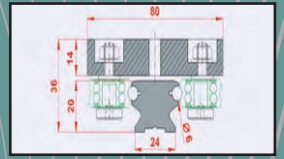

Ø 8 block guide profile

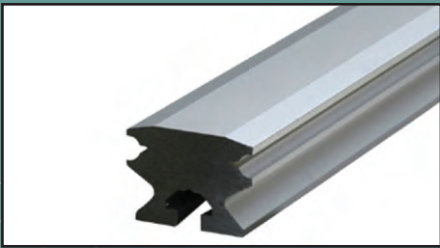

ΚΩΔΙΚΟΣ.: M 094
Μήκος: 6 m

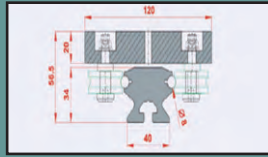

closed block guide profile

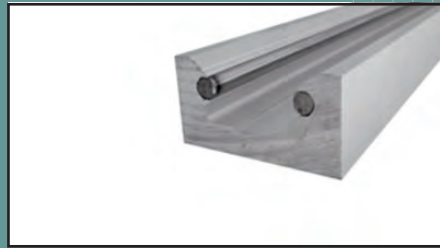

ΚΩΔΙΚΟΣ:
M 64-A

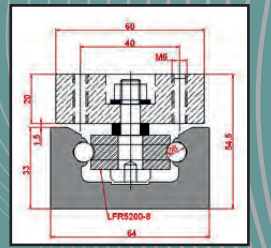

Ø 12 block profile



ΚΩΔΙΚΟΣ.: M 07
Μήκος: 6 m

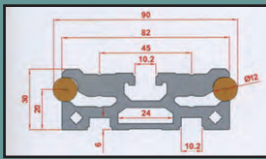

Ø 20 block profile

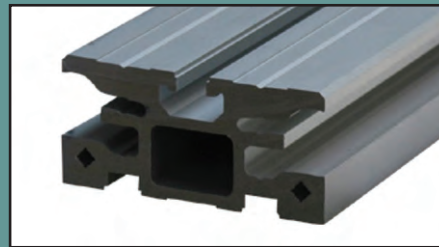

ΚΩΔΙΚΟΣ.: M 06
Μήκος: 6 m

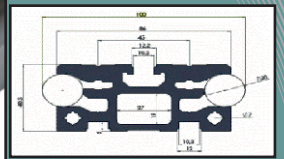

Ø 12 clumping profile



ΚΩΔΙΚΟΣ.: M 008
Μήκος: 6 m

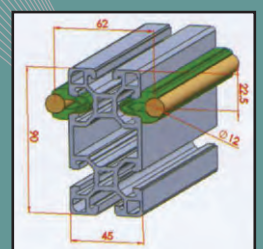

Ø 20 clumping profile



ΚΩΔΙΚΟΣ.: M 009
Μήκος: 6 m

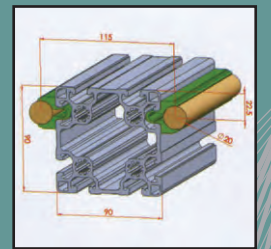

Rod shaft support profile Ø 12-16-20-25-30-40
(without hole)

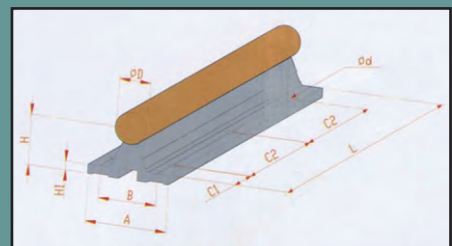
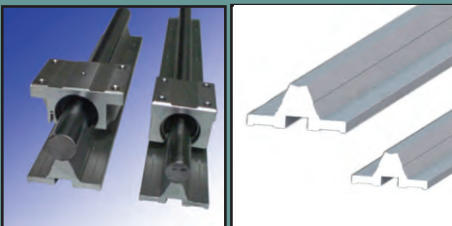

ØD	Κωδικός	Βάρος kg/m	Διαστάσεις (mm)			Μήκος: 6000 χιλιοστά				
			A	H	H1	B	Ød1	C1	C2	K DIN 6912
12	M DP 12	0,69	40	22 ±0,1	5	29	4,5	50	75	M 4x16
16	M DP 16	0,84	45	26 ±0,1	5	33	5,5	50	100	M 5x20
20	M DP 20	1,23	52	32 ±0,1	5,8	37	6,5	50	100	M 6x25
25	M DP 25	1,44	57	36 ±0,1	6	42	6,5	60	120	M 8x30
30	M DP 30	2,00	69	42 ±0,15	7	51	8,5	75	150	M 10x35
40	M DP 40	2,60	73	50 ±0,15	8	55	9	100	200	M 10x40

* Στα παραπάνω προφίλ δεν περιλαμβάνονται οι άξονες
* Το προφίλ Rod shaft βγαίνει και με τρύπες

ΣΤΟΙΧΕΙΑ ΣΥΝΔΕΣΗΣ

ΚΥΚΛΙΚΗ ΓΩΝΙΑ

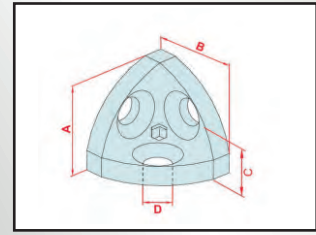
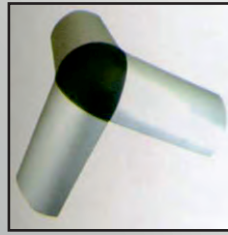

ØD	Ονομασία Προϊόντος	A	B	C	D	Υλικό	Βάρος
M 56/R	20 X 20 κυκλική γωνία	18,5	18,5	10	6,5	Αλουμίνιο	12 gr
M 55/R	30 X 30 κυκλική γωνία	28	28	15	8,5	Αλουμίνιο	42 gr
M 54/R	45 X 45 κυκλική γωνία	42	42	22,5	10,5	Αλουμίνιο	136 gr
M 96/C	20 X 20 καπάκι	-	-	-	-	Πλαστικό	2 gr
M 96/A	30 X 30 καπάκι	-	-	-	-	Πλαστικό	4 gr
M 96/B	45 X 45 καπάκι	-	-	-	-	Πλαστικό	14 gr

ΣΤΕΝΕΣ ΓΩΝΙΕΣ ΣΥΝΔΕΣΗΣ

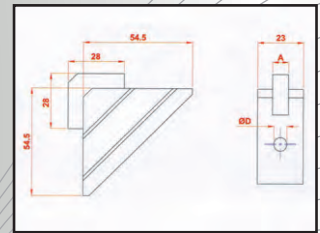

Κωδικός	Ονομασία Προϊόντος	A	Διάμετ.	Βάρος
M 55	Κανάλι 8 Στενή γωνία	8	6,5	54 gr
M 54	Κανάλι 10 Στενή γωνία	10	8,5	56 gr

STRAIGHT ΓΩΝΙΕΣ ΣΥΝΔΕΣΗΣ

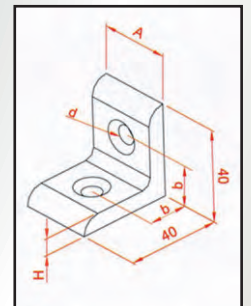

Κωδικός	Ονομασία Προϊόντος	A	B	C	D	H	Βάρος
M 53	30 X 30 Straight	28	28	22,5	ø 6	7	35 gr
M 53/A	45 X 45 Straight	40	40	22,5	ø 8,2	7	49 gr
M 53/B	80 X 80 Straight	76	76	20	ø 8,5	8,3	206 gr

ΣΤΟΙΧΕΙΑ ΣΥΝΔΕΣΗΣ

90 X 90 - 45 X 90 ΓΩΝΙΕΣ ΣΥΝΔΕΣΗΣ

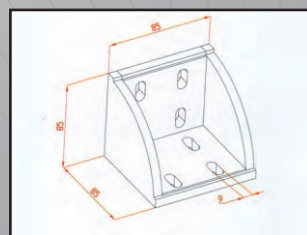
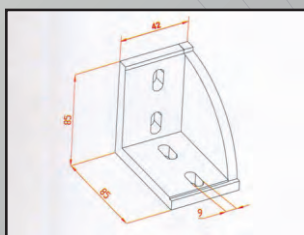

Κωδικός	Ονομασία Προϊόντος	Βάρος
M 54/U	Κανάλι 10 45x90 γωνία	186 gr
M 52	Κανάλι 10 90x90 γωνία	370 gr
M 96/D	Καπάκι 90x90	31,5 gr

45 X 45 ΓΩΝΙΕΣ ΣΥΝΔΕΣΗΣ, 30 X 30 ΓΩΝΙΕΣ ΣΥΝΔΕΣΗΣ, 20 X 20 ΓΩΝΙΕΣ ΣΥΝΔΕΣΗΣ

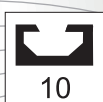
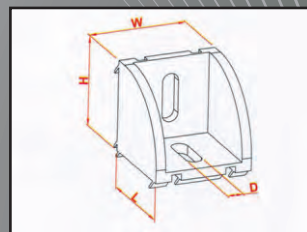

Κωδικός	Ονομασία Προϊόντος	L	H	W	D	Υλικό	Βάρος
M 54/K	Κανάλι 6 20x20	20	20	17,5	5,2	Αλουμίνιο	15,5 gr
M 55/G	Κανάλι 8 30x30	28	28	28	6,5	Αλουμίνιο	41 gr
M 54/G	Κανάλι 10 45x45	44	44	43	9	Αλουμίνιο	73,5 gr
M 96/K	Κανάλι 6 καπάκι	-	-	-	-	Πλαστικό	2 gr
M 97/G	Κανάλι 8 καπάκι	-	-	-	-	Πλαστικό	4 gr
M 96/G	Κανάλι 10 καπάκι	-	-	-	-	Πλαστικό	10 gr

ΒΙΔΕΣ HAMMER

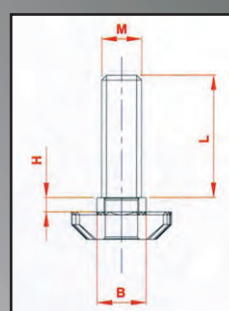
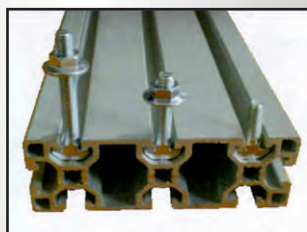

Κωδικός	Ονομασία Προϊόντος	L	M	H	W	B	Βάρος
M 40/B	Κανάλι 8 M6 x 20	20	6	2	16,5	7,7	7,5 gr
M 40/C	Κανάλι 10 M8 x 25	25	8	3	19,5	8,3	14 gr
M 40/D	Κανάλι 10 M8 x 40	40	8	3	19,5	8,3	18,5 gr
M 40/F	Κανάλι 10 M8 x 60	60	8	3	19,5	8,3	25,5 gr

ΣΤΙΣ ΒΙΔΕΣ HAMMER ΔΕΝ ΠΕΡΙΛΑΜΒΑΝΟΝΤΑΙ ΤΑ ΠΑΞΙΜΑΔΙΑ ΦΛΑΝΤΖΑΣ

ΣΤΟΙΧΕΙΑ ΣΥΝΔΕΣΗΣ

JAGGED NUTS

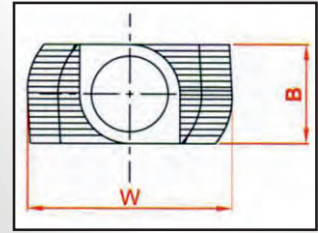
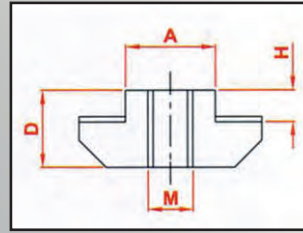
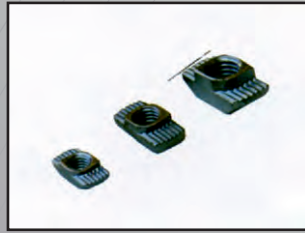
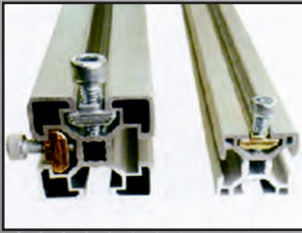

Κωδικός	Ονομασία Προϊόντος	M	B	W	D	H	A	Βάρος
M 47/A	Κανάλι 6 NUTS M4	M4	5,7	11,4	4,1	1,2	5,6	1,2 gr
M 47/S	Κανάλι 6 NUTS M5	M5	5,7	11,4	4,1	1,2	5,6	1 gr
M 42/B	Κανάλι 8 NUTS M4	M4	7,9	16	6,3	2	7,7	3,6 gr
M 42/A	Κανάλι 8 NUTS M5	M5	7,9	16	6,3	2	7,7	3,3 gr
M 42	Κανάλι 8 NUTS M6	M6	7,9	16	6,3	2	7,7	3 gr
M 43/B	Κανάλι 10 NUTS M4	M4	10	19	8,7	3	9,8	7,5 gr
M 43/A	Κανάλι 10 NUTS M5	M5	10	19	8,7	3	9,8	7 gr
M 43	Κανάλι 10 NUTS M6	M6	10	19	8,7	3	9,8	6,5 gr
M 41	Κανάλι 10 NUTS M8	M8	10	19	8,7	3	9,8	5,5 gr

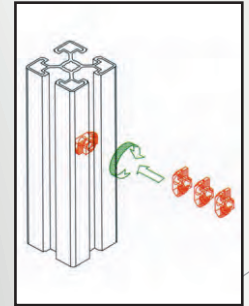

ΜΠΟΥΛΟΝΙΑ ΚΕΦΑΛΗΣ

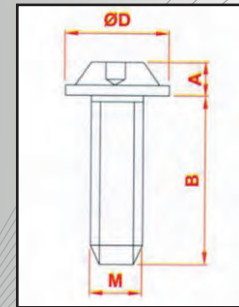
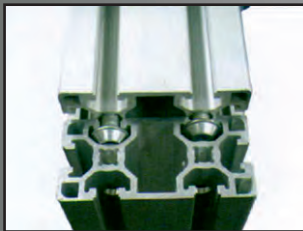

Κωδικός	Ονομασία Προϊόντος	A	B	M	ØD	Βάρος
M 44/C	Κανάλι 6 Μπουλόني	3,5	20	M6	10	4,5 gr
M 44/B	Κανάλι 8 Μπουλόني	5,2	25	M8	16	13 gr
M 44	Κανάλι 10 Μπουλόني	6	30	M10	18	21 gr

SPRING SLOT NUTS

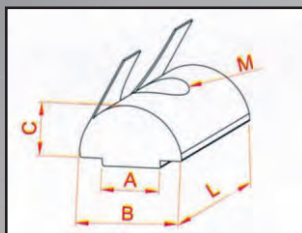

Κωδικός	Ονομασία Προϊόντος	A	B	C	M	Βάρος
M 45/Κ	Κανάλι 6 M5 NUTS	6	11	5,5	5	4,5 gr
M 45/Η	Κανάλι 6 M6 NUTS	6	11	5,5	5	4 gr
M 45/С	Κανάλι 8 M5 NUTS	8	13	5,5	5	4 gr
M 45/В	Κανάλι 8 M6 NUTS	8	13	5,5	6	5,5 gr
M 45/Д	Κανάλι 8 M8 NUTS	8	13	5,5	8	4,5 gr
M 45/Ф	Κανάλι 10 M5 NUTS	10	15	7,5	5	11,5 gr
M 45/А	Κανάλι 10 M6 NUTS	10	15	7,5	6	11,5 gr
M 45	Κανάλι 10 M8 NUTS	10	15	7,5	8	10,5 gr



ΣΤΟΙΧΕΙΑ ΣΥΝΔΕΣΗΣ

ΣΥΝΔΕΣΜΟΣ PULLER TYPE



8

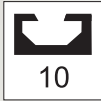

10

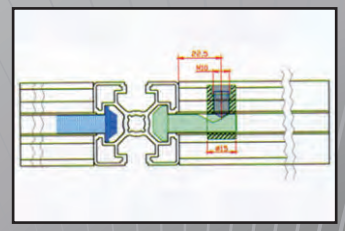
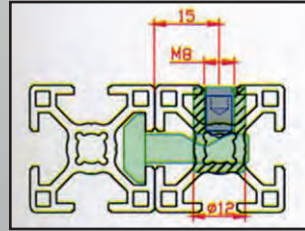
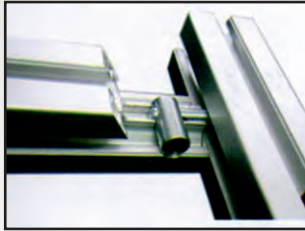

Κωδικός	Ονομασία Προϊόντος	Βάρος
M 85/A	Κανάλι 8 PULLER	24 gr
M 85	Κανάλι 10 PULLER	55 gr

ΣΥΝΔΕΣΜΟΣ PULLER TYPE DOUBLE

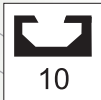

10

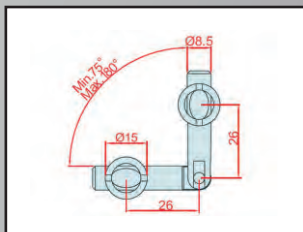

Κωδικός	Ονομασία Προϊόντος	Βάρος
M 85/B	Κανάλι 10 PULLER DOUBLE	84,5 gr

ΣΥΝΔΕΣΜΟΣ PULLER TYPE SINGLE

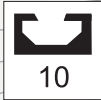

10

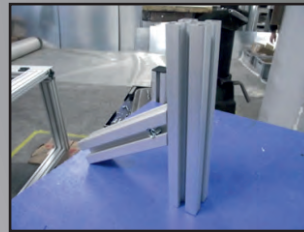
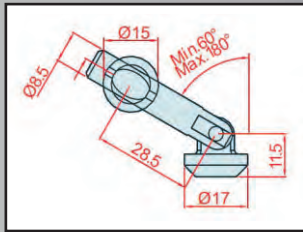

Κωδικός	Ονομασία Προϊόντος	Βάρος
M 85/C	Κανάλι 10 PULLER SINGLE	53 gr

INNER CONNECTION



8



10

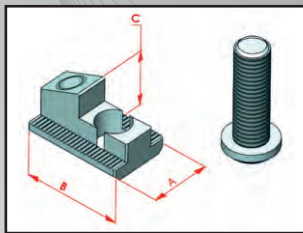

Κωδικός	Ονομασία Προϊόντος	M	A	B	C	Βάρος
M 86/B	Κανάλι 8 INNER	8	15	26,4	12,5	15 gr
M 86/J	Κανάλι 10 INNER	10	19	30	17,5	27 gr

ΣΤΟΙΧΕΙΑ ΣΥΝΔΕΣΗΣ

LONG NUTS

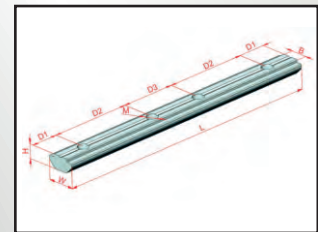
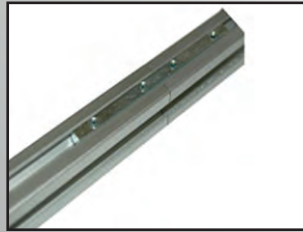

Κωδικός	Ονομασία Προϊόντος	L	H	B	W	D1	D2	D3	M	Βάρος
M 107A	Κανάλι 6 Long nuts	100	5	6	10	10	30	20	M5	29 gr
M 107B	Κανάλι 8 Long nuts	120	6	7,8	16	7,5	35	35	M6	77,5 gr
M 107C	Κανάλι 10 Long nuts	140	10,5	10	20	15	40	30	M8	150 gr

SMALL NUTS

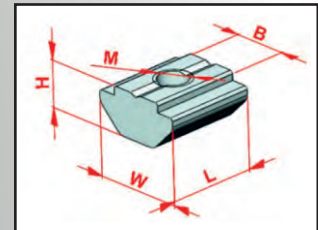
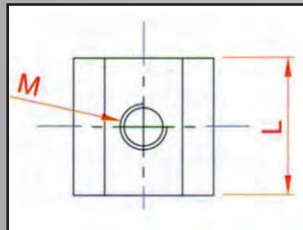

Κωδικός	Ονομασία Προϊόντος	M	B	W	L	H	Βάρος
M 102T	Κανάλι 6 Small nuts M4	M4	6	10	10	5	2,5 gr
M 102R	Κανάλι 6 Small nuts M5	M5	6	10	10	5	2 gr
M 102Z	Κανάλι 6 Small nuts M6	M6	6	10	10	5	2 gr
M 102L	Κανάλι 8 Small nuts M5	M5	7,8	16	16	6	8,5 gr
M 102F	Κανάλι 8 Small nuts M6	M6	7,8	16	16	6	8,5 gr
M 102E	Κανάλι 8 Small nuts M8	M8	7,8	16	16	6	7,5 gr
M 102C	Κανάλι 10 Small nuts M5	M5	10,1	20	20	10,5	20,5 gr
M 102B	Κανάλι 10 Small nuts M6	M6	10,1	20	20	10,5	19,5 gr
M 102A	Κανάλι 10 Small nuts M8	M6	10,1	20	20	10,5	18,5 gr



ΓΩΝΙΑ ΚΡΥΦΗΣ ΣΥΝΔΕΣΗΣ

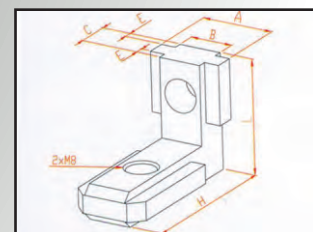

Κωδικός	Ονομασία Προϊόντος	A	B	C	M	E	L	Βάρος
M 106	Κανάλι 6-Κρυφή γωνία	9	6	4,8	M5	1,5	13,5	6 gr
M 106A	Κανάλι 8-Κρυφή γωνία	13	8	6,7	M6	1,4	21,2	18,5 gr
M 106B	Κανάλι 10-Κρυφή γωνία	17	10	8,5	M8	2	27	41 gr

ΕΞΑΡΤΗΜΑΤΑ ΣΥΝΔΕΣΗΣ

ΤΡΙΓΩΝΗ ΓΩΝΙΑ 40 X 40

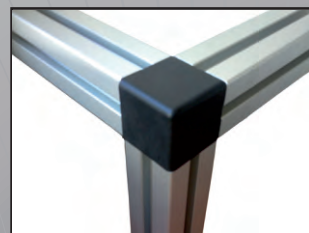
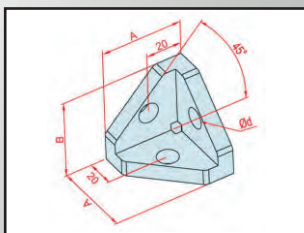
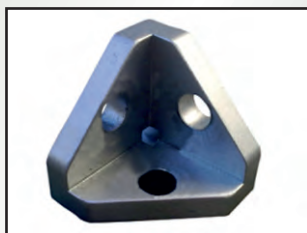

Κωδικός	Ονομασία Προϊόντος	A	B	D	Βάρος
M 1/T	Τρίγωνη 40 x 40	36	36	Ø 8,5	56 gr
M 2/T	Καπάκι 40 x 40	40	40	Ø 8,5	7 gr

ΚΙΝΗΣΗ ΑΡΘΡΩΣΕΩΝ

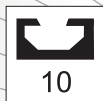
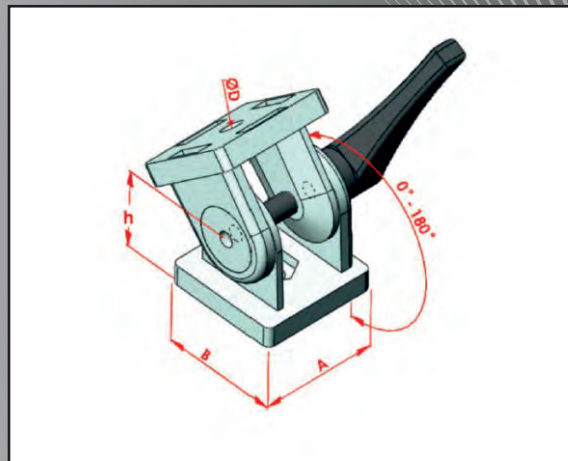

Κωδικός	Ονομασία Προϊόντος	A	B	D	H	Βάρος
M 36	30 X 30	30	30	Ø8,5	22,5	154 gr
M 37/A	40 X 40	40	40	Ø8,5	30	372 gr
M 37	45 X 45	45	45	Ø10,5	30	342 gr

90° ΣΥΝΔΕΤΗΡΑΣ

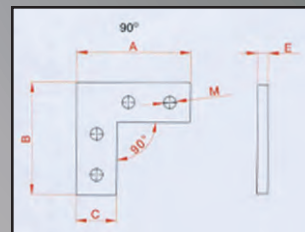
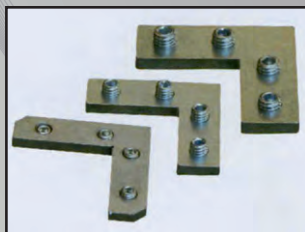

Κωδικός	Ονομασία Προϊόντος	A	B	C	M	E	Βάρος
M 034/A	20 X 20 90°	45	45	9,3	4	3	17 gr
M 032/A	25 X 25 90°	45	45	12,3	5	4	30 gr
M 034	30 X 30 90°	45	45	14	6	4	33,5 gr
M 032	45 X 45 90°	55	55	19,5	8	5	71 gr



ΕΞΑΡΤΗΜΑΤΑ ΣΥΝΔΕΣΗΣ

120°-135° ΣΥΝΔΕΤΗΡΑΣ

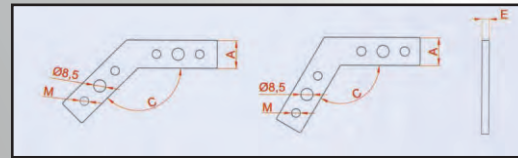
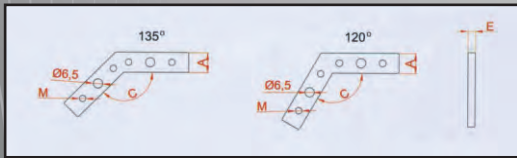
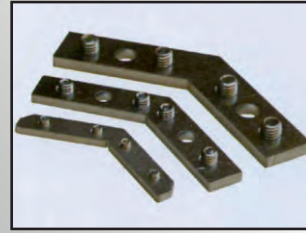

Κωδικός	Ονομασία Προϊόντος	A	M	C	E	Βάρος
M 35/G	20x20 120°	9,3	4	120°	3	17 gr
M 35/E	25x25 120°	12,3	5	120°	4	27 gr
M 35	30x30 120°	14	6	120°	4	43 gr
M 33	45x45 120°	19,5	8	120°	5	92 gr
M 34/D	20x20 135°	9,3	4	135°	3	16 gr
M 32/B	25x25 135°	12,3	5	135°	4	27 gr
M 35/A	30x30 135°	14	6	135°	4	41 gr
M 33/A	45x45 135°	19,5	8	135°	5	88 gr

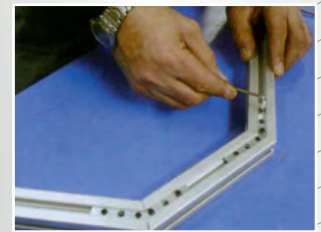

ΜΕΤΑΛΛΙΚΗ ΡΥΘΜΙΣΗ ΡΑΦΙΟΥ

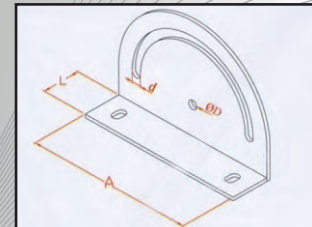

Κωδικός	Ονομασία Προϊόντος	A	L	d	ØD	Βάρος
M 98	Κανάλι 8 Μεταλλικό ράφι	120	30	6,5	6,5	247,5 gr
M 98/Κ	Κανάλι 10 Μεταλλικό ράφι	120	38	8,5	8,5	242,5 gr

ΣΤΗΡΙΞΗ ΠΟΔΙΩΝ

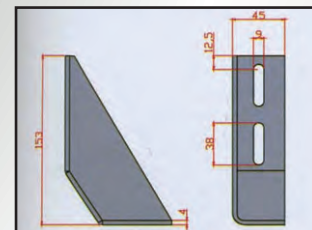

Κωδικός	Ονομασία Προϊόντος	A	B	C	ØD	Βάρος
M 57	Στήριξη ποδιού	153	45	92	9	488,5 gr

ΕΞΑΡΤΗΜΑΤΑ ΣΥΝΔΕΣΗΣ

ΔΙΠΛΗΣ ΚΑΤΕΥΘΥΝΣΗΣ ΣΥΝΔΕΤΙΚΗ ΠΛΑΚΑ

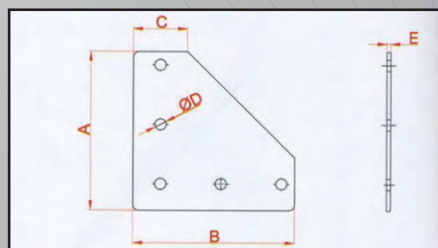

Κωδικός	Ονομασία Προϊόντος	A	B	C	ØD
M 051	20 X 25 Σύνδεση Διπλή	75	75	20	5
M 72/A	30 X 30 Σύνδεση Διπλή	80	80	26	6,5
M 56	45 X 45 Σύνδεση Διπλή	120	120	40	8,5
M 66	90 X 90 Σύνδεση Διπλή	240	240	80	8,5

ΤΡΙΠΛΗΣ ΚΑΤΕΥΘΥΝΣΗΣ ΣΥΝΔΕΤΙΚΗ ΠΛΑΚΑ

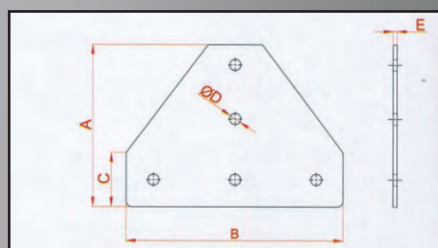

Κωδικός	Ονομασία Προϊόντος	A	B	C	ØD
M 051/A	20 X 25 Σύνδεση Τριπλή	75	86	20	5
M 72/B	30 X 30 Σύνδεση Τριπλή	90	150	26	6,5
M 56/A	45 X 45 Σύνδεση Τριπλή	120	160	40	8,5
M 66/A	90 X 90 Σύνδεση Τριπλή	200	250	85	8,5

ΤΕΤΡΑΠΛΗΣ ΚΑΤΕΥΘΥΝΣΗΣ ΣΥΝΔΕΤΙΚΗ ΠΛΑΚΑ

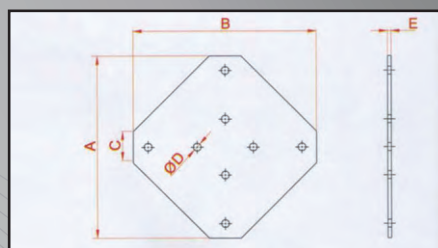
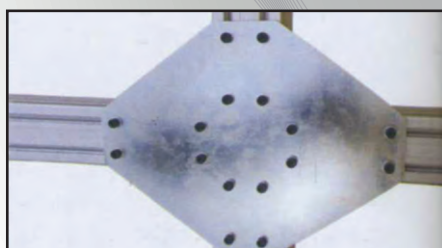

Κωδικός	Ονομασία Προϊόντος	A	B	C	ØD
M 51/B	20X25 Σύνδεση Τετραπλή	130	130	20	5
M 72/C	30X30 Σύνδεση Τετραπλή	150	150	26	6,5
M 56/B	45X45 Σύνδεση Τετραπλή	180	180	40	8,5
M 66/B	90X90 Σύνδεση Τετραπλή	311	311	85	8,5

ΤΟ ΥΛΙΚΟ ΕΙΝΑΙ ΑΠΟ ΛΑΜΑΡΙΝΑ ΓΑΛΒΑΝΙΖΕ ΠΑΧΟΥΣ 3 χιλ.
ΚΑΤΟΠΙΝ ΠΑΡΑΓΓΕΛΙΑΣ ΕΙΝΑΙ ΔΙΑΘΕΣΙΜΟ ΣΕ ΑΛΟΥΜΙΝΙΟ & ΙΝΟΧ

ΕΞΑΡΤΗΜΑΤΑ ΚΑΜΠΙΝΑΣ

ΜΑΓΝΗΤΕΣ

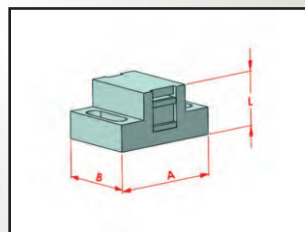
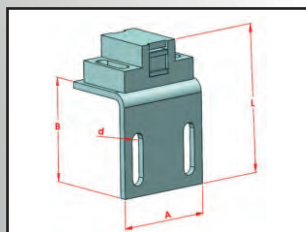

Κωδικός	Ονομασία Προϊόντος	A	B	L	ØD	Βάρος
M 069/D	Κανάλι 6 Μαγνήτης	45	20	40	5,5	88,5 gr
M 69/B	Κανάλι 8 Μαγνήτης	45	35	55	6,5	104 gr
M 069	Κανάλι 10 Μαγνήτης	45	47	67	6,5	113 gr



ΛΑΒΗ ΚΑΙ ΚΛΕΙΔΩΜΑ



Κωδικός	Ονομασία Προϊόντος	L	L1	B	C	Βάρος
M 67	Πλαστική λαβή	131,5	91,5	25	19,5	44,5 gr
M 69/F	Πλαστική μπάλα λαβή	74	57	77	40	40 gr

ΚΩΔΙΚΟΣ: M 67

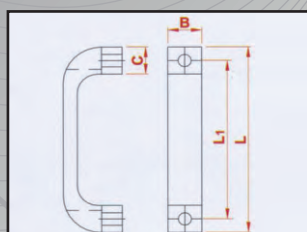

ΚΩΔΙΚΟΣ: M 69/F

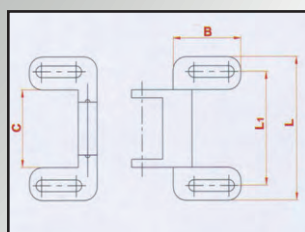

ΕΞΑΡΤΗΜΑΤΑ ΚΑΜΠΙΝΑΣ

ΜΕΝΤΕΣΕΔΕΣ ΠΛΑΣΤΙΚΟΙ



6



8

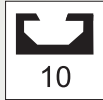

10

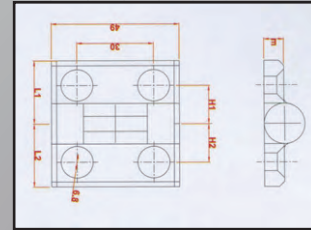
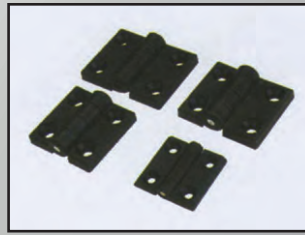

Κωδικός	Ονομασία Προϊόντος	H1	H2	L1	L2	E	Βάρος
M 65/K	20 x 20 Μεντεσές	10	10	19	19	4,5	6,5 gr
M 65/G	25 x 25 Μεντεσές	12,5	12,5	20	20	5	14 gr
M 65/A	30 x 30 Μεντεσές	15	15	25	25	8	27 gr
M 65/B	35 x 35 Μεντεσές	17,5	17,5	32	32	8	40,5 gr
M 65/C	45 x 45 Μεντεσές	22,5	22,5	32	32	8	32,5 gr
M 65/D	45 x 30 Μεντεσές	22,5	15	32	25	8	30 gr
M 65/E	40 x 40 Μεντεσές	22,5	17,5	32	32	8	33 gr

ΕΞΑΡΤΗΜΑ ΣΥΝΔΕΣΗΣ ΠΟΔΙΩΝ

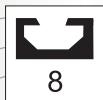

8

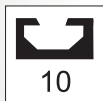

10

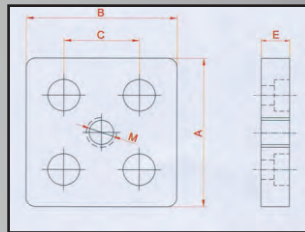
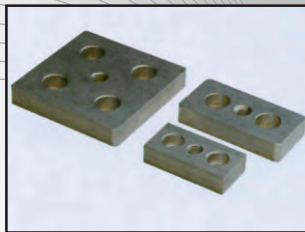

Κωδικός	Ονομασία Προϊόντος	A	B	C	M	E	Βάρος
M 81/C	30X60 Εξάρτημα ποδιών	30	60	30	M8	15	61 gr
M 81/B	45X45 Εξάρτημα ποδιών	45	65	40	M10	15	84 gr
M 81/A	45X90 Εξάρτημα ποδιών	45	90	45	M12	20	145,5 gr
M 81	90X90 Εξάρτημα ποδιών	90	90	45	M16	20	290 gr
M 81/E	40X80 Εξάρτημα ποδιών	40	80	40	M10	20	110 gr
M 81/G	80X80 Εξάρτημα ποδιών	80	80	40	M12	20	223 gr

ΕΞΑΡΤΗΜΑΤΑ ΚΑΜΠΙΝΑΣ

ACCORDION SLIDING PIN

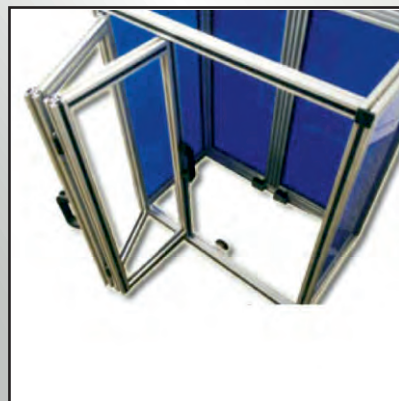
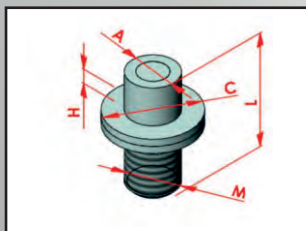

Κωδικός	Όνομασία Προϊόντος	A	C	H	L	M	Βάρος
M 75/D	Accordion sliding pin 8	8	15	3	24	8	7 gr
M 75/C	Accordion sliding pin 10	10	18	3	27	10	12 gr

SLIDING DOOR GUIDE

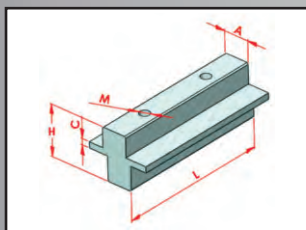
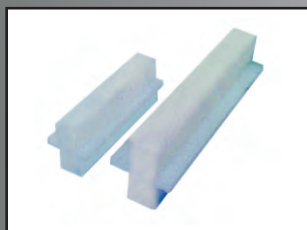

Κωδικός	Όνομασία Προϊόντος	A	C	H	L	M	Βάρος
M 75/B	Sliding door 8	8	2	18,7	53	4	8,5 gr
M 75/A	Sliding door 10	10	2,5	20,3	60	4	13 gr

CLAMP CABLE HOLDER

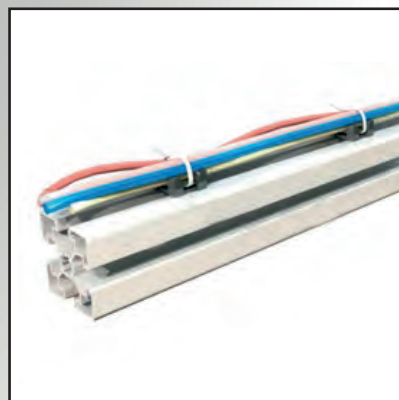
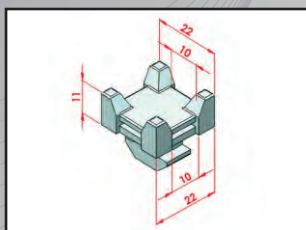

Κωδικός	Όνομασία Προϊόντος	Βάρος
M 83	Clamp cable 10	5,9 gr

LOCK CABLE HOLDER

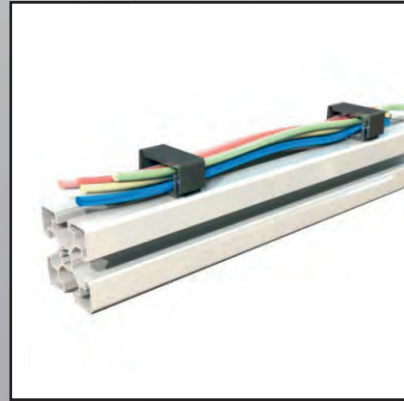
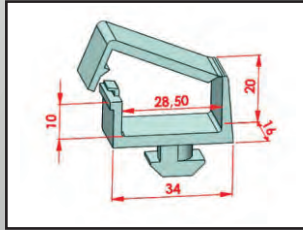

Κωδικός	Ονομασία Προϊόντος	Βάρος
M 82	Lock cable 10	6,5 gr

DAMPERS

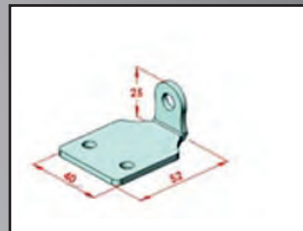
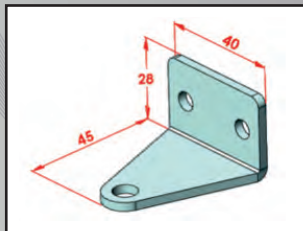
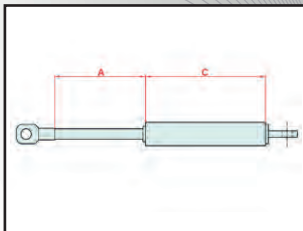

Κωδικός	Ονομασία Προϊόντος	A	C	H	Βάρος
M 84	Dampers 150mm F300N	150	195	-	205 gr
M 84/B	Dampers 105mm F150N	105	145	-	159 gr
M 84/C	Dampers 85mm F85N	85	130	-	148 gr
M 84/D	Dampers connection	45	40	28	48 gr
M 84/F	Dampers connection N2	52	40	25	50 gr

ΕΞΑΡΤΗΜΑΤΑ ΚΑΜΠΙΝΑΣ

PANEL MOUNTING BLOCK

Panel Mounting Block 6

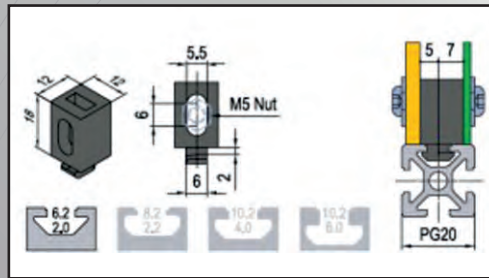

Panel Mounting Block 8

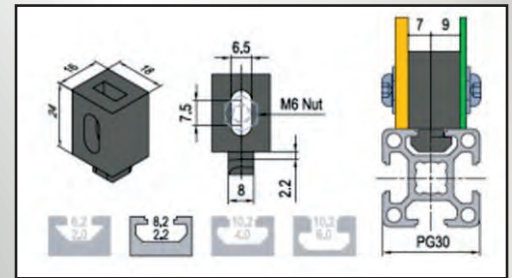

Panel Mounting Block 10-4

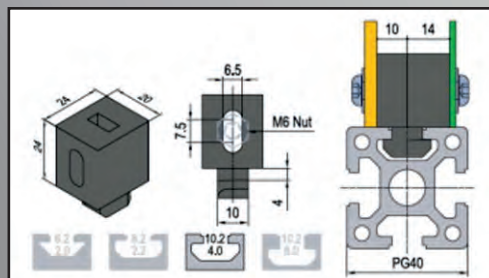

Panel Mounting Block 10-6

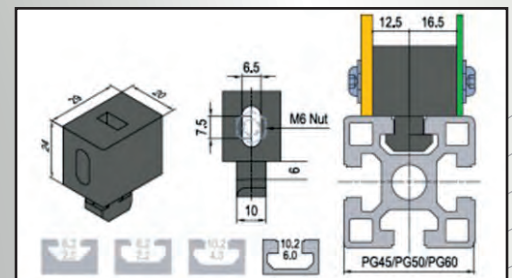

ΠΑΡΕΛΚΟΜΕΝΑ ΣΥΝΔΕΣΗΣ

ΠΟΔΙΑ ΧΡΩΜΙΟΥ & ΠΛΑΣΤΙΚΑ



Κωδικός	Ονομασία Προϊόντος	D	M	H	h	Βάρος	Φορτίο
M 62/D	M6 Πλαστικό πόδι	Ø 40	M6	80	45	36,5 gr	100 kr
M 62	M8 Πλαστικό πόδι	Ø 40	M8	80	40	43,5 gr	200 kr
M 61	M10 Πλαστικό πόδι	Ø 60	M10	100	50	123,5 gr	250 kr
M 61/C	M12 Πλαστικό πόδι	Ø 60	M12	95	50	135,5 gr	300 kr
M 61/B	M16 Πλαστικό πόδι	Ø 110	M16	160	110	318 gr	500 kr
M 62/C	M10 Πόδι χρωμίου	Ø 60	M10	85	60	169,5 gr	300 kr
M 62/B	M12 Πόδι χρωμίου	Ø 80	M12	140	90	455 gr	400 kr
M 62/A	M16 Πόδι χρωμίου	Ø 120	M16	145	100	942 gr	500 kr

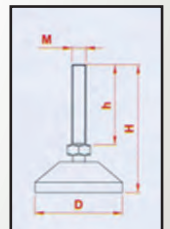

ΠΑΡΕΛΚΟΜΕΝΑ ΣΥΝΔΕΣΗΣ

ΤΡΟΧΟΙ



8

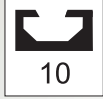

10

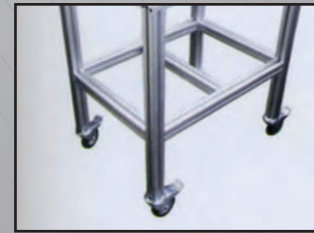
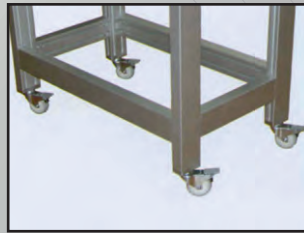

Κωδικός	∅	Ονομασία Προϊόντος	Βάρος φόρτωσης
M 99/A	50	Ρόδα τρελή Φ 50*	45 kg
M 99/B	50	Ρόδα τρελή Φ 50 με φρένο*	45 kg
M 99/C	75	Ρόδα τρελή Φ 75*	55 kg
M 99/D	75	Ρόδα τρελή Φ 75 με φρένο*	55 kg

*Κατόπιν παραγγελίας υπάρχουν ρόδες που δέχονται περισσότερο βάρος φόρτωσης

ΚΑΠΑΚΙΑ ALUMINIUM PROFILE

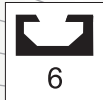
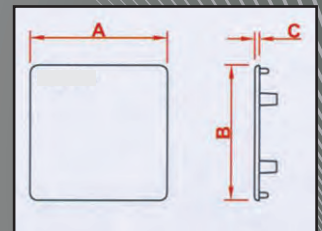
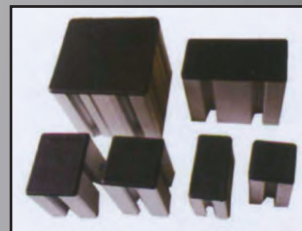
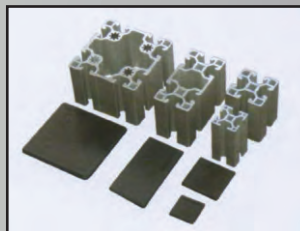

6

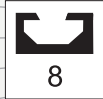

8

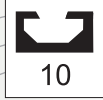

10

Κωδικός	Ονομασία Προϊόντος	A	B	C	Βάρος
M 58/P	20 X 20 Τάπα	20	20	3	1 gr
M 58/B	20 X 40 Τάπα	20	40	3	2 gr
M 58/F	20 X 80 Τάπα	20	80	3	4 gr
M 58/R	25 X 25 Τάπα	25	25	3	1,5 gr
M 58/A	30 X 30 Τάπα	30	30	3	3,5 gr
M 58/H	35 X 35 Τάπα	35	35	3	4 gr
M 58/N	30 X 60 Τάπα	30	60	3	7 gr
M PK 40X40	40 X 40 Τάπα	40	40	3	5 gr
M PK 40X80	40 X 80 Τάπα	40	80	3	10 gr
M 58/C	45 X 45 Τάπα	45	45	3	7,5 gr
M 58/J	45 X 60 Τάπα	45	60	3	9 gr
M 58/D	45 X 90 Τάπα	45	90	3	15 gr
M 58/G	60 X 60 Τάπα	60	60	3	11 gr
M PK 80X80	80 X 80 Τάπα	80	80	3	19 gr
M 58/E	90 X 90 Τάπα	90	90	3	30,5 gr
M 58/X	20 X 20 Radius τάπα	20	20	3	1 gr
M 58/L	30 X 30 Radius τάπα	30	30	3	2,5 gr
M 58/M	45 X 45 Radius τάπα	45	45	3	7 gr

ΠΑΡΕΛΚΟΜΕΝΑ ΣΥΝΔΕΣΗΣ

ΧΡΩΜΑΤΙΣΤΑ ΚΑΝΑΛΙΑ



6



8



10

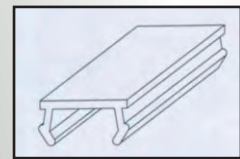
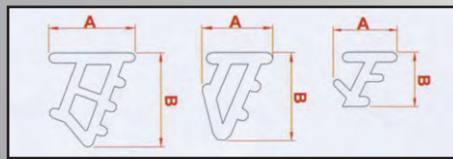
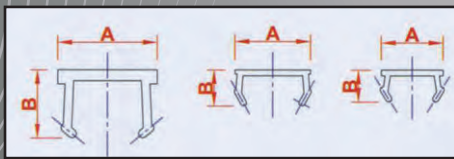
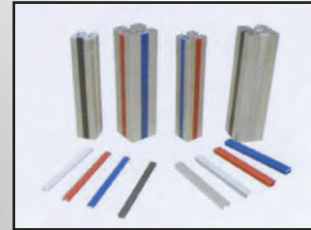
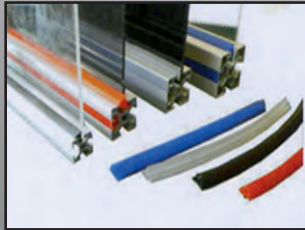

Κωδικός	Ονομασία Προϊόντος	A	B
M 79	Κανάλι 6 Ράγα	7,3	3,8
M 49	Κανάλι 8 Ράγα	8,9	4,3
M 59	Κανάλι 10 Ράγα	11,7	8,1
M 70	Κανάλι 6 Ράγα glass	8,1	7
M 72	Κανάλι 8 Ράγα glass	9	11,3
M 71	Κανάλι 10 Ράγα glass	11	12,1

Plexi Glass



8



10

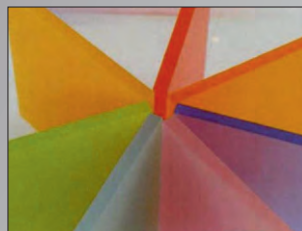

ΚΑΤΟΠΙΝ ΠΑΡΑΓΓΕΛΙΑΣ
ΔΙΑΤΙΘΟΝΤΑΙ ΣΕ ΠΟΛΛΟΥΣ
ΧΡΩΜΑΤΙΣΜΟΥΣ ΚΑΙ
ΔΙΑΣΤΑΣΕΙΣ

Κωδικός	Ονομασία Προϊόντος	C
M 86	Plexi Glass 3mm	3
M 86/A	Plexi Glass 4mm	4
M 86/B	Plexi Glass 5mm	5
M 86/C	Plexi Glass 6mm	6
M 87/C	Plexi Glass 8mm	8
M 86/D	Plexi Glass 10mm	10

ΕΦΑΡΜΟΓΕΣ

CNC Router



Ρομπότ καμπίνα αποθήκευσης



Οδηγός μονής γέφυρας



Rated chassis

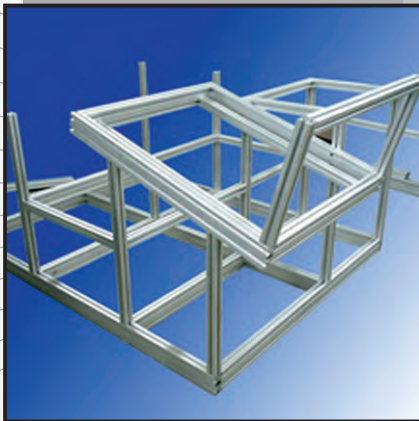

Καμπίνα μηχανής

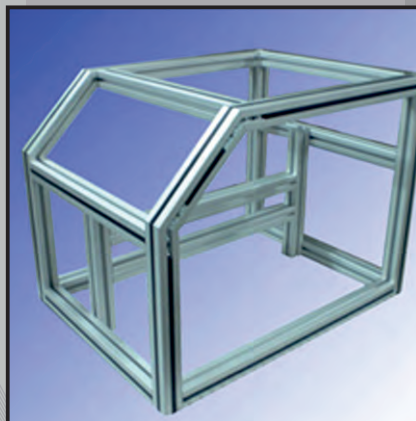

Τραπέζι



Πάγκος - Τραπέζι



CNC / Robotics

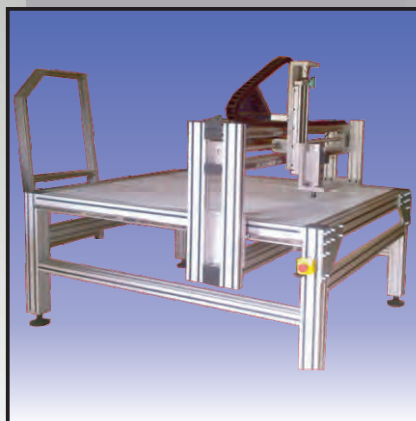

Βάση μηχανής μεταξοτυπίας



ΕΦΑΡΜΟΓΕΣ

Βάση στερέωσης
μηχανής



Βάση μηχανής

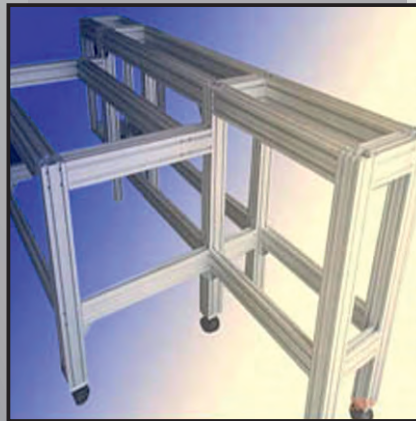

Τραπέζι για
laser



Fair stand



Βάση ασανσέρ



Σκάλες



CNC
Plexi & Wood

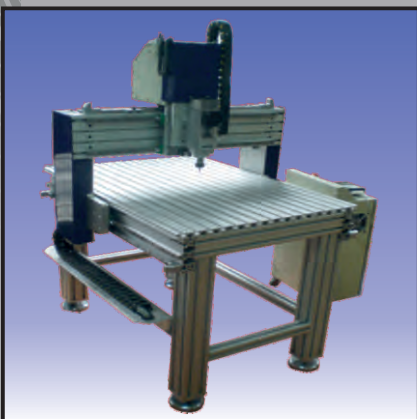

Εκπαιδευτικός
πίνακας



Σύστημα γραμμικής
κίνησης

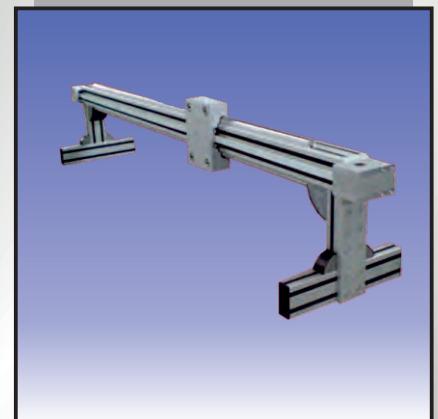

ΣΥΣΤΗΜΑΤΑ ΒΙΟΜΗΧΑΝΙΚΩΝ ΜΕΤΑΦΟΡΕΩΝ



ΣΥΣΤΗΜΑΤΑ ΓΡΑΜΜΙΚΗΣ ΚΙΝΗΣΗΣ (οδηγοί)

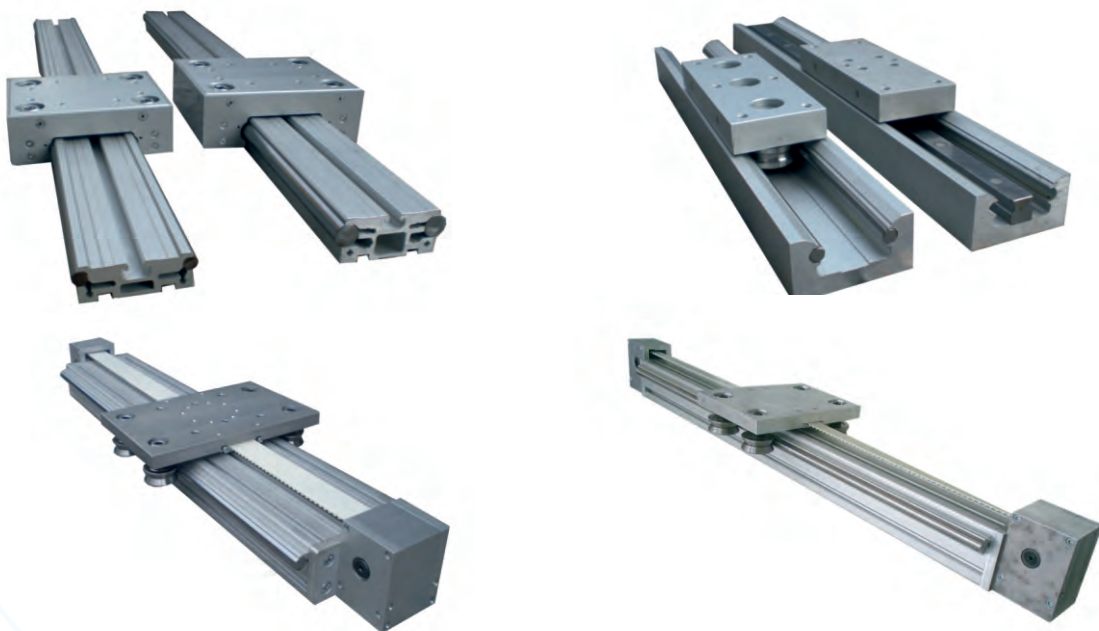

Τα μηχανήματα διατίθενται κατόπιν παραγγελίας

ΤΑ ΠΡΟΪΟΝΤΑ ΕΙΝΑΙ ΚΑΤΑΣΚΕΥΑΣΜΕΝΑ
ΣΥΜΦΩΝΑ ΜΕ ΤΟ ISO 9001:2008

Aluminium Profile

e-mail: sales@aluminium-profile.gr
www.aluminium-profile.gr

Η εταιρία μας Αφοί ΜΕΪΜΑΡΙΔΗ Ο.Ε. εκτός από τα προϊόντα του καταλόγου διαθέτει και άλλα είδη αλουμινίου όπως:

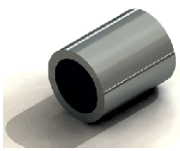

ΣΩΛΗΝΕΣ

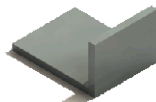

ΓΩΝΙΕΣ



ΜΑΣΙΦ

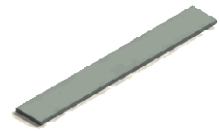

ΛΑΜΕΣ

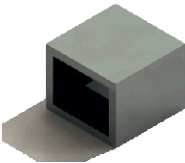

ΚΑΡΡΕ

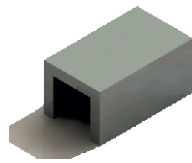

ΠΙ

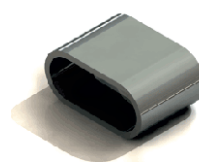

ΟΒΑΛ

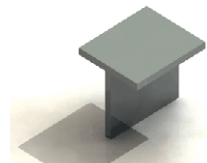

ΤΑΥ



ΠΑΡΑΔΟΣΙΑΚΑ
ΚΑΓΚΕΛΑ

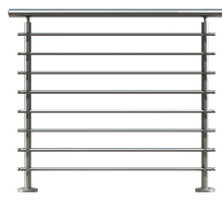

ΚΑΓΚΕΛΑ
ΤΥΠΟΥ ΙΝΟΧ



ΑΥΛΟΠΟΡΤΕΣ



ΦΡΑΧΤΕΣ



ΕΠΙΠΕΔΑ ΠΑΝΕΛ

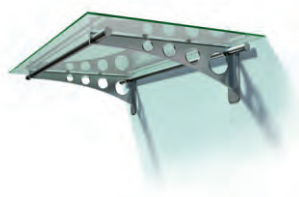

ΣΥΣΤΗΜΑΤΑ
ΣΚΙΑΣΗΣ

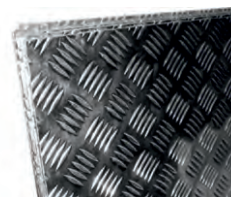

ΛΑΜΑΡΙΝΕΣ



ΠΟΡΤΕΣ



ΕΜΠΟΡΙΑ ΣΙΔΗΡΟΥ - ΑΛΟΥΜΙΝΙΟΥ - ΓΥΨΟΣΑΝΙΔΑΣ - ΧΡΩΜΑΤΩΝ
ΣΟΒΑΔΩΝ - ΙΝΟΧ ΠΑΝΤΟΣ ΤΥΠΟΥ - ΒΙΟΜΗΧΑΝΙΚΑ ΕΡΓΑΛΕΙΑ
(ΣΤΡΑΝΤΖΑ - ΨΑΛΙΔΙ - ΚΥΛΙΝΔΡΟΣ - ΠΑΝΤΟΓΡΑΦΟΣ)

ΑΦΟΙ ΜΕΪΜΑΡΙΔΗ Ο.Ε.

Σταδίου 97 - Βέροια
Τηλ.: 23310 23342 - 23178 / Fax: 23310 67869
www.meimaridis.gr | info@meimaridis.gr

e-mail: sales@aluminium-profile.gr
www.aluminium-profile.gr

